

KEITHLEY

Model 590 CV Analyzer
Quick Reference Guide

A GREATER MEASURE OF CONFIDENCE

INTRODUCTION

This quick reference guide contains descriptions of various features and information concerning the operation of the Model 590. Also included are programming examples using various controllers.

©1986, Keithley Instruments, Inc.
Instrument Division
Cleveland, Ohio, U.S.A.
Document Number: 590-903-01 Rev. A

CONTENTS

Front Panel Operation	4
Control Group	4
Trigger Group	7
Bias Group	9
Plotter Group	11
Data Group	14
Miscellaneous Functions	16
Mathematical Functions	18
Displays	19
Connections	20
Waveform Definitions	24
IEEE-488 Programming	34
Device-Dependent Commands	34
Data Format	43
SRQ Mask and Status Byte Format	45
U0 to U26 Status Word Formats	46
Translator	64
Programs	67
IBM PC or XT	68
Apple II	70
HP-85	72
HP-9816	74
HP-9825A	76
DEC LSI 11	78
PET/CBM 2001	80

SAFETY PRECAUTIONS

1. Before operation, ground the instrument through a properly earth grounded power receptacle.
2. Before servicing, disconnect the instrument from the power line and all other equipment, and consult the Model 590 Instruction Manual.
3. Do not touch any terminals while the instrument is turned on or connected to any other test equipment.

For additional safety information, see the "Safety Precautions" pages in the back of this manual.

FRONT PANEL OPERATION

LOCAL—Pressing this key when the unit is in remote (REMOTE on) returns the instrument to the local mode (REMOTE off) and restores operation of other front panel controls unless LLO (local lockout) is in effect.

POWER—Controls AC line power to the instrument.

CONTROL GROUP

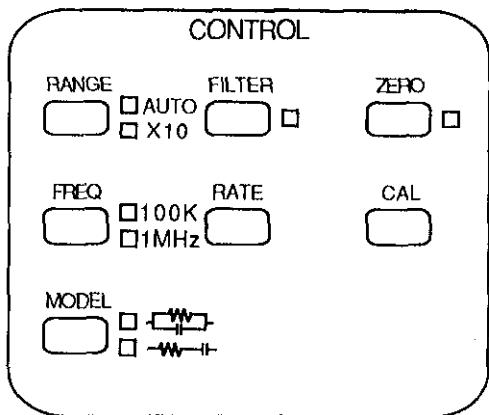

RANGE—Press RANGE briefly to manually select range. Pressing and holding RANGE for more than ½ second places the unit in autoranging. Press RANGE again to cancel auto and stay on present range. **SHIFT RANGE** switches in X10 attenuator to extend 100kHz measurement range to 20nF with external optional input adapter (Model 5904).

FREQ—Press FREQ to select test frequency, 100kHz or 1MHz at 15mV RMS. An error message will be displayed if the appropriate modules are not installed, or if you attempt to use the X10 attenuator at 1MHz. FREQ is also used to disconnect the test signal from the test jacks. (The display will show DISCONNECT.)

MODEL—MODEL selects series or parallel device model (series resistance and capacitance or parallel conductance and capacitance).

Full Scale Conductance/Resistance:

100kHz		1MHz	
Conductance	Resistance	Conductance	Resistance
2 μ S	2M Ω	20 μ S	2M Ω
20 μ S	200 k Ω	200 μ S	200 k Ω
200 μ S	20 k Ω	2mS	20 k Ω
2mS	2 k Ω	20mS	2 k Ω
20mS	200 Ω		

FILTER—FILTER toggles the single-pole 37 Hz low-pass analog filter on and off. Note that the filter increases instrument response time.

RATE--Press RATE then ▲/▼ (or RATE) to scroll through the rate selection menu: 1, 10, 75, or 1000 readings per second (or press the numeric key indicated below). Press ENTER to select RATE, or QUIT to return to the previous rate. The slower rates will provide more resolution and quieter readings, as indicated below.

Key #	Nominal Rate	Resolution	Readings	Digital Filtering
0	1000/sec	3½ *	C only	No
1	75/sec	3½ *	C,G,V	No
2	10/sec	4½	C,G,V	Yes
3	1/sec	4½	C,G,V	Yes

*Data displayed only after sweep is finished.

NOTE: Rates are nominal; see instruction manual for actual rates.

ZERO--ZERO provides means for suppression of a constant value from the readings, or it can be used to cancel internal offsets to maximize accuracy. Note that enabling zero can reduce the dynamic range of the measurement.

CAL--Pressing CAL performs an automatic one point calibration of the selected module on the current range using an internal 20pF or 200pF (depending on range) capacitor and is intended to compensate for short-term thermal drift. CAL should be used for each range at both frequencies for optimum accuracy of those ranges.

NOTE

Do not press and hold CAL when power is first turned on, as the instrument will go into its diagnostic program.

TRIGGER GROUP

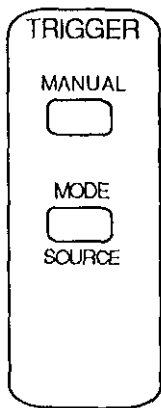

MANUAL—Pressing **MANUAL** will initiate a one-shot or sweep sequence depending on the selected trigger mode. This key is always operational regardless of the selected trigger source. Pressing **MANUAL** while a reading or sweep *is in progress* will result in a *trigger overrun error message*. Dashes in the display indicates that a trigger is required.

MODE—Press **MODE** then **▲/▼**, **MODE**, or numeric key (see list below) to select a trigger mode: one shot or sweep, then press **ENTER**. In one-shot, the instrument will process one reading per trigger, while in sweep the unit will process a complete reading sweep.

SOURCE—Press **SHIFT SOURCE** then **MODE** or **▲/▼** to scroll through available trigger sources (or press the appropriate numeric key in the list below), and then press **ENTER**.

Front panel modes and sources include:

Numeric Key #	Display Message	Description
0	TRIGGER MODE 1-SHOT	One reading per trigger
1	TRIGGER MODE SWEEP	One sweep per trigger
0	TRIGGER SOURCE FP	Front Panel MANUAL button*
1	TRIGGER SOURCE EXT	External trigger pulse
2	TRIGGER SOURCE TALK	IEEE talk command
3	TRIGGER SOURCE GET	IEEE GET command
4	TRIGGER SOURCE X	IEEE X command

*Always enabled regardless of selected source.

BIAS GROUP

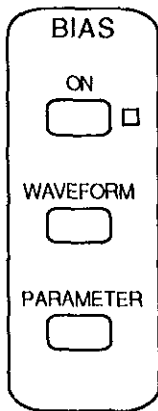

ON—The ON key turns the internal or external bias voltage, which is applied through the OUTPUT jack, on or off.

WAVEFORM—Selects the type of bias waveform to be programmed, or the external bias source, as indicated below. Use WAVEFORM, ▲/▼, or appropriate numeric key to select the waveform type, then press ENTER.

Available waveforms include:

Numeric Key#	Display Message	Description
0	DC	Constant DC level in the range of $\pm 20V$.
1	STAIR	Single staircase (step either up or down).
2	DSTAIR	Dual staircase (step up then down or down then up).
3	PULSE	Pulse train (constant level or step up or down).
4	EXT	Voltage from external source (BIAS INPUT jack).

PARAMETER—Use **PARAMETER** or **▲/▼** to select parameter to be programmed, then key in the value using the numeric keys. Press **ENTER** when finished programming all parameters.

Programmable parameters include:

Display Message	Limits	Resolution
START TIME	1msec to 65sec	1msec
STOP TIME	1msec to 65sec	1msec
STEP TIME	1msec to 65sec	1msec
FIRST BIAS V	-20V to +20V	5mV
LAST BIAS V	-20V to +20V	5mV
STEP BIAS V	-20V to +20V	5mV
DEFAULT BIAS V	-20V to +20V	5mV
COUNT*	1-450 (1,350 at 1,000/sec rate)	

- *Selects number of readings stored for external and DC bias waveforms.
- **Voltages may be programmed in 1mV steps, but are set in 5mV steps.

NOTE: Multiply programmed times by 1.024 for actual time intervals.

PLOTTER GROUP

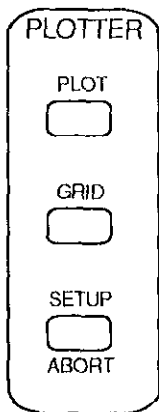

PLOT—Pressing PLOT plots the data located in the selected buffer (A or B) on an intelligent plotter over the IEEE-488 bus using the current SETUP parameters. The plotter must be set to the addressable mode using a primary address of 5. The controller must be disconnected from the bus for stand-alone plotting.

GRID—Pressing GRID draws labels, axes, and other parameters as appropriate for the selected buffer and the SETUP parameters.

SETUP—Pressing SETUP enters the plotter setup menu which allows selection of the parameters below. Use increment or decrement to scroll through menu selections then press the appropriate number (below) when desired selection is displayed, then ENTER.

ABORT—Press SHIFT ABORT to cease plotting or grid generation.

Setup Parameter	Line Type	Grid Type	Label Type	Plot Type	Pen Type	Buffer	XY Scaling
0	Dot at points	Full grid	Full labels	C vs V	No pen	A	Auto scale
1	Spaced dots	Axis only	Labels axis and divisions	G vs V*	#1	B	User-defined
2	Dashes	-	Labels axis only	1/C ² vs V	#2	-	-
3	Long dash	-	-	C/C ₀ vs V	-	-	-
4	Dash dot	-	-	C vs t	-	-	-
5	Long dash, short dash	-	-	C _A -C _B vs V	-	-	-
6	Long dash, short dash, long dash	-	-	[V _A -V _B] C=CONST	-	-	-
7	Solid line	-	-	-	-	-	-

*R vs V for series model

DATA GROUP

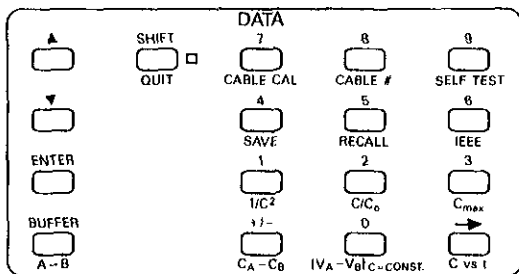

Increment (▲)—Increment is used to scroll through menu selections for other front panel operating modes such as TRIGGER MODE, PLOTTER SETUP, and BIAS WAVEFORM. Increment is also used to scroll through buffer locations when displaying buffer data.

Decrement (▼)—Like the increment key, decrement is used to scroll through parameter menus and buffer locations, but in the opposite direction.

ENTER—ENTER is used as the last step in the menu or parameter selection process to actually perform the operation being programmed.

QUIT—Pressing QUIT when scrolling through a parameter menu will return the instrument to the normal front panel display and restores the previously programmed mode. QUIT also exits the buffer.

BUFFER—Pressing BUFFER allows you to view the contents of buffer A or buffer B on the front panel displays. Once in this mode, select the desired buffer (A or B) and use increment or decrement to sequentially access various buffer locations. The BUFFER LED will be on while the unit is displaying buffer data. Pressing BUFFER while accessing the buffer displays the last valid buffer location. Pressing ENTER displays the first valid buffer location (location #1).

A → B—Places the entire contents of buffer A into buffer B, including capacitance, conductance, and bias voltage values. Buffer A is the buffer into which A/D readings are stored. Buffer A will be cleared after the data is transferred.

SHIFT—SHIFT adds a secondary function to certain other front panel keys, including BUFFER. If you press a key which has no second function after enabling shift, the primary function of that key will be performed.

NUMERIC DATA KEYS (0-9, ±, →)—These keys are used to enter numeric data when programming such items as bias parameters. If you wish to restore the previously programmed values, press the QUIT key instead of ENTER. Pressing the → key scrolls the cursor to the right.

MISCELLANEOUS FUNCTIONS

To access the following modes, press SHIFT before the key in question.

CABLE CAL—Pressing this key performs open-circuit cable correction only at 1MHz. Note that the opposite ends of the connecting cables must be left open during the correction process. Once the correction is complete, you will be given an opportunity to store the correction scheme for the particular cable (0-6) you are using at the update option. Note that cable correction reduces the dynamic range of the measurement.

CABLE #—Use this key to select which of seven previously stored cable correction setups obtained above that you wish to use (0-6). Once selected, the unit will automatically use the previously stored cable correction parameters when making measurements. Note that correction setup #7 turns off cable correction and installs default values to the front panel.

SELF TEST—Use this key to perform a self test on many internal components, including display and the hardware multiplier.

SAVE—SAVE allows you to save up to seven complete instrument configurations in NVRAM. To use this feature, simply select the operating configuration and then press the SAVE button. Key in the position (0-6) that you wish to save. Note that state 0 is the configuration the unit will assume upon power up.

RECALL—Use RECALL to assume machine operating configurations that were stored with the SAVE key, or the factory configuration. Upon entering this mode, you will be prompted for a configuration number. Key in the value (0-7) and press ENTER. Note that state 7 is a factory default configuration permanently stored in ROM and cannot be altered. State 0 is the configuration the instrument assumes upon power up.

The following modes can be saved and recalled.

Mode	Factory Default
Range	2nF
Frequency	100kHz *
Filter	On
Rate	10/sec
Zero	Off
Trigger Mode	Sweep
Trigger Source	Front Panel
Bias Source	Off
Waveform	DC
Start, stop, step time	1msec
First, last, step, default bias	0V
Count	450

*590/100k or 590/100k/1M

IEEE—Press IEEE to verify or program the IEEE-488 primary address. Use the number keys to select a primary address value (0-30). Press ENTER to program the new address. The programmed address will go into effect immediately, and is stored in non-volatile RAM.

MATHEMATICAL FUNCTIONS

The following calculations are performed on data presently stored in the data buffers and are not stored in memory. In order to use these functions, you must select buffer display with the BUFFER key.

$1/C^2$ —Pressing $1/C^2$ inverts the capacitance value in each data word of the selected buffer and then squares it; the value for each point will be displayed as you access that word location.

C/C_0 —This feature allows you to display normalized capacitance data. The maximum capacitance value is used for C_0 .

C_{max} —Pressing C_{max} displays the maximum capacitance value stored in the selected buffer.

$C_A - C_B$ —This key allows you to subtract each capacitance value in buffer B from the corresponding values in buffer A.

$[V_A - V_B]C = \text{CONST.}$ —This function rotates the C-V plot axis by 90° and gives a display of the change in voltage (ΔV) as a function of constant capacitance.

C vs t—While in C vs t, you can use $\blacktriangle/\blacktriangledown$ to scroll through various buffer locations. The buffer location number will be shown in the bias voltage display. You can calculate the time at a specific location for DC and staircase waveforms as follows:

$$tB = [t_{start} + (t_{step} + 1/R) (B)] \times 1.024$$

Where: tB = time at a specific buffer location
tstart = programmed start time
tstep = programmed step time
R = reading rate (readings per second)
B = buffer location number

NOTE

Use actual reading rates as described in instruction manual.

DISPLAYS

CAPACITANCE DISPLAY—The normal capacitance display is a 4½ digit +21,999, -19,999 count value with engineering units in pF or nF. Note that display resolution is 3½ digits at the 75 and 1000 reading per second rates.

CONDUCTANCE DISPLAY—The nominal conductance display is a 4½ digit (3½ digits at the 75 and 1000 reading per second rates), +21,999, -19,999 count value, with engineering units also displayed in μ S or mS for conductance (parallel model) or k Ω or M Ω for resistance (series model).

BIAS VOLTAGE DISPLAY—The 4½ digit bias voltage display indicates the programmed or actual measured value of the internal ± 20 V bias source or the applied external bias voltage (± 200 V). While programming bias parameters, the display will show the programmed value. When the unit is displaying readings or stored buffer values, the display will show the bias voltage as measured by an internal A/D converter. This display will also show buffer location in C vs t. Note that display resolution is 3½ digits at the 75 and 1000 reading per second rates.

CONNECTIONS

FRONT PANEL

Test INPUT and OUTPUT—Connect the device under test to the test INPUT and OUTPUT jacks as shown in Figure 1. Use RG-58 coaxial cable for best results. Cable correction should be used when measuring at 1MHz for optimum accuracy.

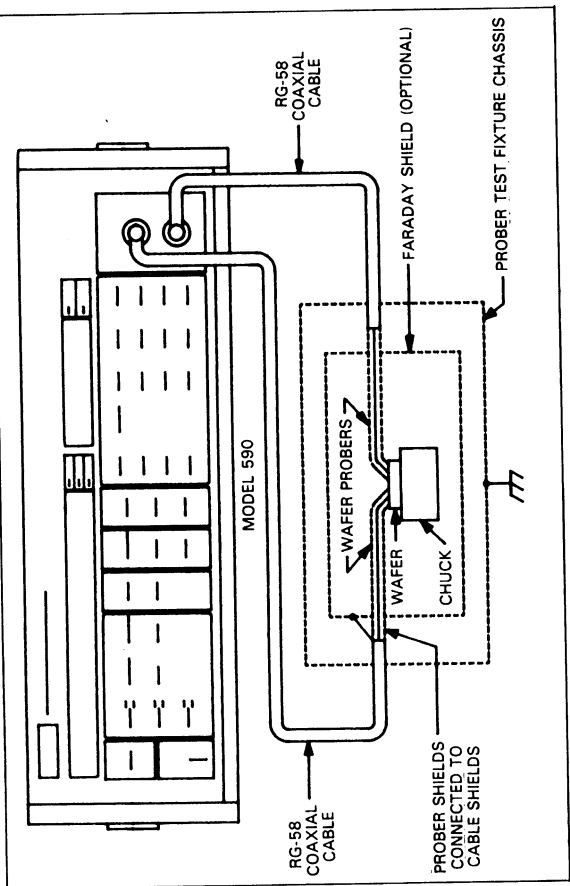

Figure 1. Typical Test Connections

REAR PANEL

VOLTAGE BIAS INPUT—This BNC connector is intended to apply external bias voltage up to $\pm 200\text{V DC}$, 50mA maximum. Note that the input is internally fused to protect the instrument from over current conditions.

VOLTAGE BIAS OUTPUT—This BNC output jack provides a means to monitor the selected bias voltage (external or internal) applied to the circuit under test.

CONDUCTANCE ANALOG OUTPUT—This output jack provides a scaled voltage proportional to the conductance reading. The range of the output is 0-2V, full scale. For example, the nominal output value will be 1V with a $10\mu\text{S}$ reading on the 20pF/20 μS range.

CAPACITANCE ANALOG OUTPUT—This BNC jack provides a scaled output voltage that is proportional to the capacitance reading. The output range of the CAPACITANCE output is 0-2V full scale. For example, the nominal output voltage with a 140pF reading on the 200pF/200 μS range will be 1.4V.

EXTERNAL TRIGGER INPUT—A BNC jack to be used for applying a trigger pulse to initiate a one-shot or sweep reading. Pulse specifications are shown in Figure 2.

EXTERNAL TRIGGER OUTPUT—This BNC jack provides a pulse when the instrument completes a one-shot reading or reading sweep, depending on the selected trigger mode. Output pulse specifications are shown in Figure 3.

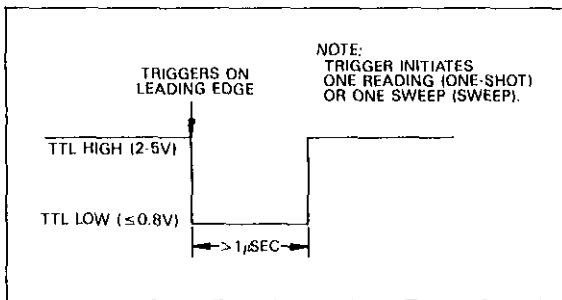

Figure 2. External Trigger Input Pulse Specifications

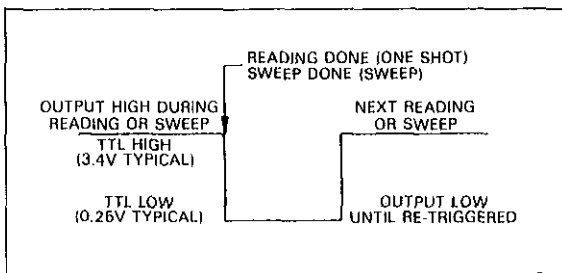

Figure 3. External Trigger Output Pulse Specifications

WAVEFORM DEFINITIONS

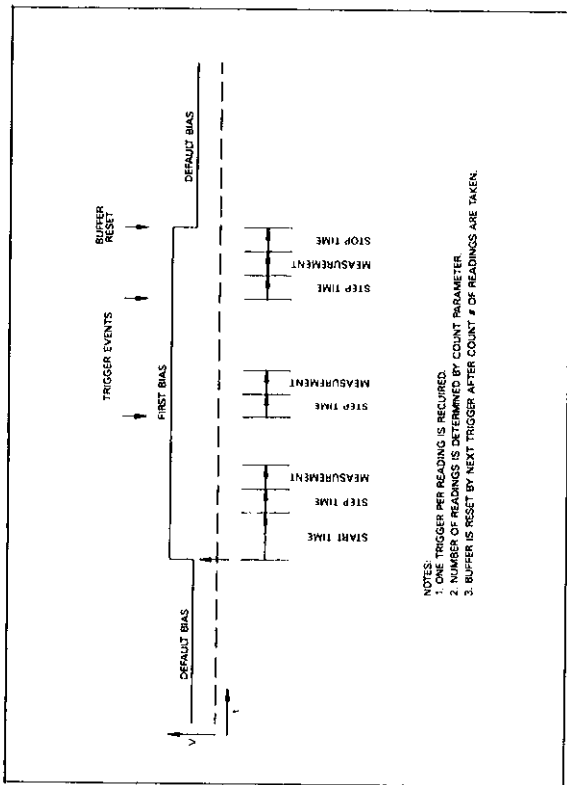
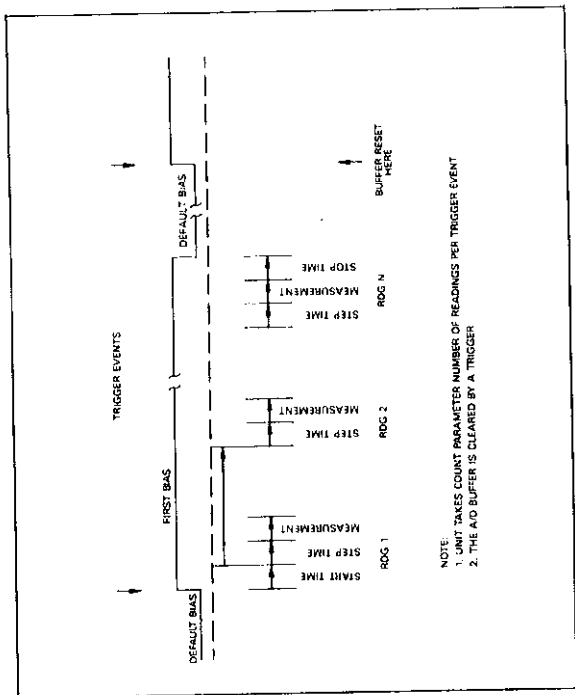

Figure 4. DC, One-Shot



NOTE:
 1. UNIT TAKES COUNT PARAMETER NUMBER OF READINGS PER TRIGGER EVENT
 2. THE A/D BUFFER IS CLEARED BY A TRIGGER

Figure 5. DC, Sweep

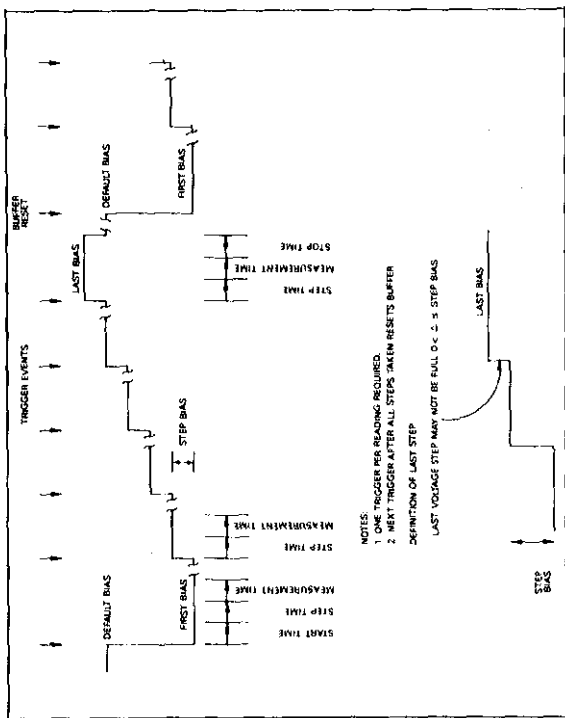

Figure 6. Single, Staircase, One-Shot

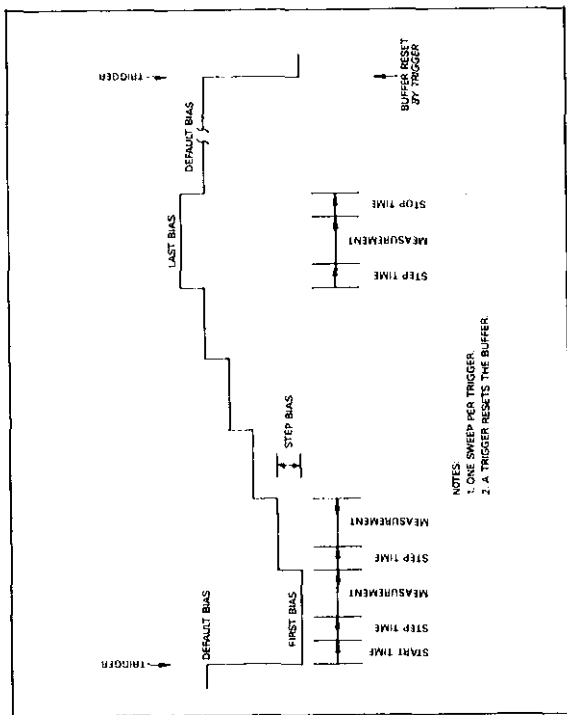
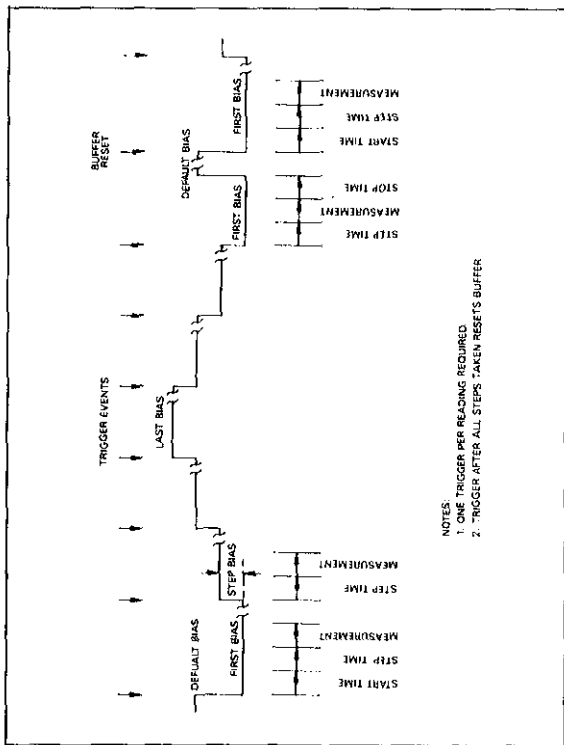

Figure 7. Single Staircase, Sweep



- NOTES:
1. ONE TRIGGER PER READING REQUIRED
 2. TRIGGER AFTER ALL STEPS TAKEN RESETS BUFFER

Figure 8. Dual Staircase, One-Shot

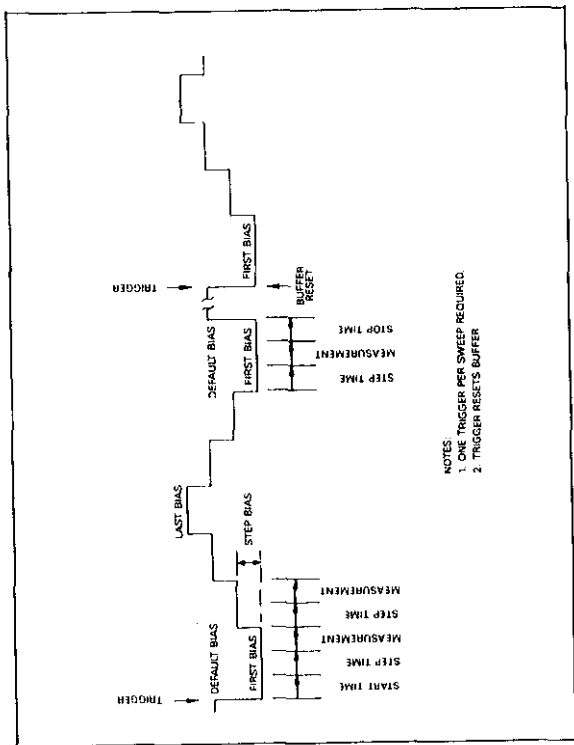
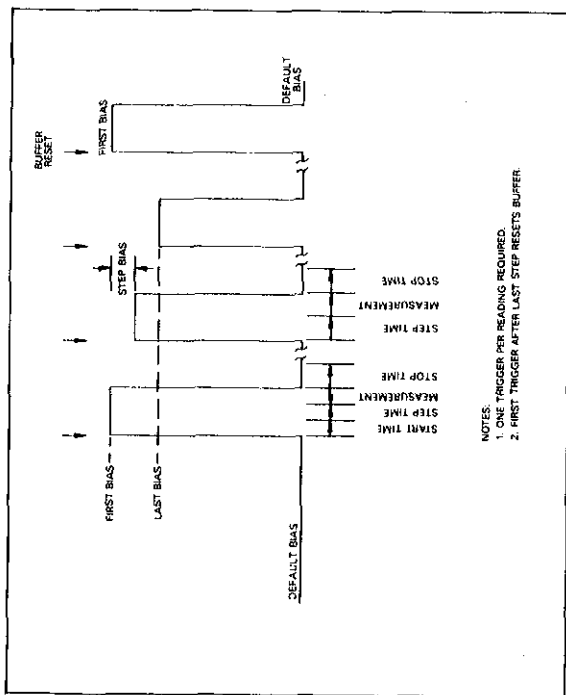

Figure 9. Dual Staircase, Sweep



- NOTES:
1. ONE TRIGGER PER READING REQUIRED.
 2. FIRST TRIGGER AFTER LAST STEP RESETS BUFFER.

Figure 10. Pulse Train, One-Shot

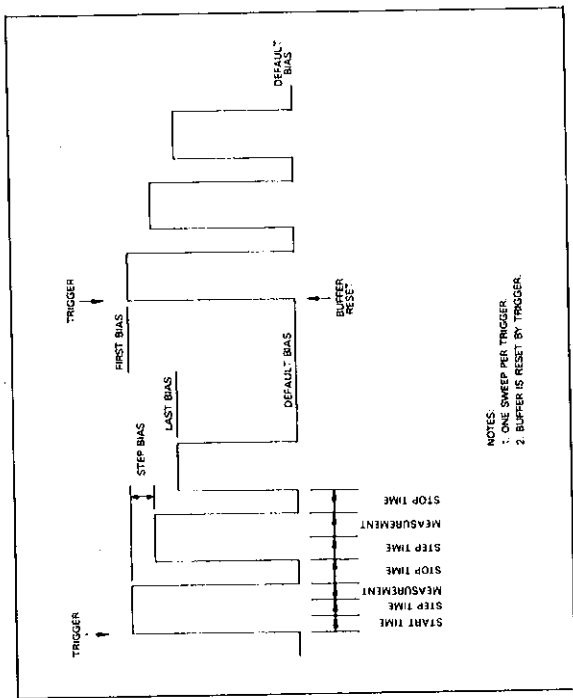

Figure 11. Pulse Train, Single Sweep

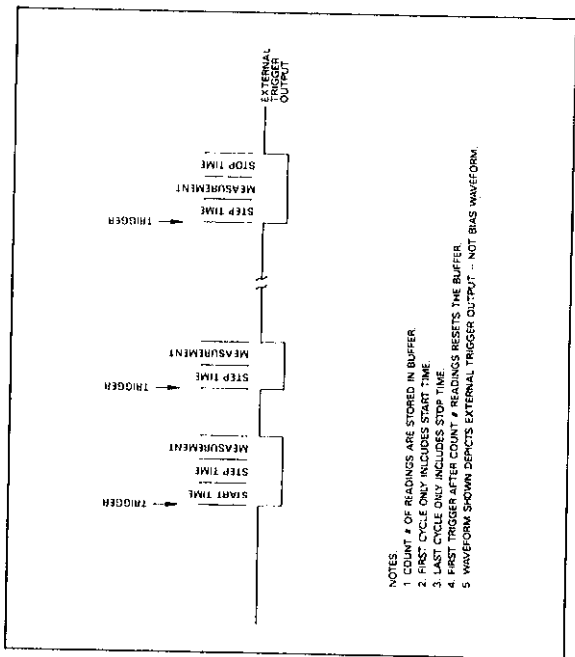
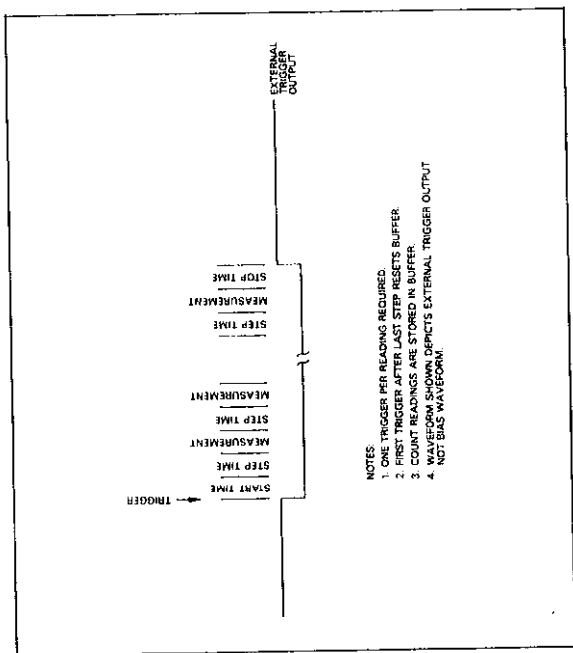

Figure 12. External, One-Shot

NOTES:

1. COUNT # OF READINGS ARE STORED IN BUFFER.
2. FIRST CYCLE ONLY INCLUDES STOP TIME.
3. LAST CYCLE ONLY INCLUDES START TIME.
4. FIRST TRIGGER AFTER COUNT # READINGS RESETS THE BUFFER.
5. WAVEFORM SHOWN DEPICTS EXTERNAL TRIGGER OUTPUT -- NOT BIAS WAVEFORM.



- NOTES:
1. ONE TRIGGER PER READING REQUIRED.
 2. FIRST TRIGGER AFTER LAST STEP RESETS BUFFER.
 3. COUNT READINGS ARE STORED IN BUFFER.
 4. WAVEFORM SHOWN DEPICTS EXTERNAL TRIGGER OUTPUT NOT BIAS WAVEFORM!

Figure 13. External, Single-Sweep

IEEE-488 PROGRAMMING

DEVICE-DEPENDENT COMMANDS

Plotter (A)	
A0	Execute plot
A1	Execute grid
A2, plot	Plot: 0 = C vs V; 1 = G vs V; 2 = $1/C^2$ vs V; 3 = C/C_0 vs V; 4 = C vs t; 5 = $[C_A - C_B]$ vs V; 6 = $[V_A - V_B]C = \text{CONST}$
A3, grid	Grid: 0 = Full grid; 1 = Axis only
A4, buffer	Buffer: 0 = A/D buffer (A); 1 = Plot buffer (B)
A5, pen	Pen: 0 = No pen; 1 = Pen #1; 2 = Pen #2
A6, line	Line: 0 = DOT at points; 1 = Spaced dots; 2 = Dashes; 3 = Long dash; 4 = Dash dot; 5 = Long dash, short dash; 6 = Long, short, long dash; 7 = Solid line
A7, label	Label: 0 = Full labels; 1 = Label axis and divisions; 2 = Label axis only
A8,n, Xmin, Xmax	X axis limits. n = 0: Autoscaling (minimum/maximum bias). n = 1: Program X axis minimum (Xmin) and maximum (Xmax) values.
A9,n, Ymin, Ymax	Y axis limits. n = 0: Default values, 0 to full scale. n = 1: Program Y axis minimum (Ymin) and maximum (Ymax) values

Buffer (B)	
B0	Current Reading
B1(,first)(,last)	A/D buffer, first, last limits
B2(,first)(,last)	Plot buffer, first, last limits
B3	Transfer A/D buffer to plot buffer

Save/Recall Cable Setups (C)	
C0,n	Recall cable #n ($0 \leq n \leq 7$)
C1,n	Save cable #n ($0 \leq n \leq 6$)

Display (D)	
Daaa	Display ASCII characters aa (20 max)
DX	Return display to normal

Frequency (F)	
F0	100kHz
F1	1MHz
F2	Disconnect test signal

Data Format (G)	
G0	Prefix on, suffix off, 1rdg
G1	Prefix off, suffix off, 1 rdg
G2	Prefix on, suffix on, 1 rdg
G3	Prefix on, suffix off, n rdgs
G4	Prefix off, suffix off, n rdgs
G5	Prefix on, suffix on, n rdgs
	n rdgs = # readings in buffer

Hit Button (H)	
H12	Emulate button press: SHIFT
H15	ENTER
H16	(A→B)
H20	ON
H23	MANUAL
H25	ZERO
H26	CAL
H27	FILTER
H29	RANGE
H30	FREQ
H31	MODEL

Cable Parameters (I)	
I0	Measure cable parameters (driving point)
I1, n1, n2, n3, n4	Assign cable parameters $K0(n1 + jn2)$, $K1(n3 + jn4)$
I2, n1, n2, n3, n4, n5, n6, n7, n8	Assign test output cable parameters: $A(n1 + jn2)$, $B(n3 + jn4)$, $C(n5 + jn6)$, $D(n7 + jn8)$
I3, n1, n2, n3, n4 n5, n6, n7, n8	Assign test INPUT cable parameters: $A(n1 + jn2)$, $B(n3 + jn4)$, $C(n5 + jn6)$ $D(n7 + jn8)$
I4	Zero cable open
I5, C, G	Measure source parameters, step 1
I6, C, G	Measure source parameters, step 2

Self Test (J)	
J1	Perform self test

EOI and Hold-off (K)	
K0	EOI and hold-off enabled
K1	EOI disabled, hold-off enabled
K2	EOI enabled, hold-off disabled
K3	EOI and hold-off disabled

Save/Recall (L)	
L0,n	Recall configuration n ($0 \leq n \leq 7$)
L1,n	Save configuration n ($0 \leq n \leq 6$)

SRQ (M)	
M0	Disabled
M1	Reading overflow
M2	Module input overload
M4	Sweep done
M8	Reading done
M16	Ready
M32	Error
M128	IEEE output done

Bias Control (N)	
N0	Bias off
N1	Bias on

Operation (O)	
Output(,model) (,C ₀)	Output: 0=C, G, V (triple); 1=C only; 2=G only; 3= V only; 4=1/C ² ; 5=C/C ₀ ; 6=C _A -C _B ; 7=(V _A -V _B)C _{CONST} . Model: 0=Parallel; 1=Series. C ₀ (used with C/C ₀): 0≤C ₀ ≤20E-9

Filter (P)	
P0	Filter off
P1	Filter on

Calibration (Q)	
Q0	Drift correction NORMAL MODE
Q1	Offsets
Q2, C, G	First capacitance cal point
Q3, C, G	Second capacitance cal point
Q4, C, G	Conductance cal point DRIVING POINT MODE
Q5	Offsets
Q6, C, G	First capacitance cal point
Q7, C, G	Second capacitance cal point
Q8	Voltage calibration offsets
Q9, V	Calibrate voltmeter gain

Range (R)		
	100kHz	1MHz
R0	Autorange on	Autorange on
R1	2pF/2 μ S	20pF/200 μ S
R2	20pF/20 μ S	20pF/200 μ S
R3	200pF/200 μ S	200pF/2mS
R4	2nF/2mS	2nF/20mS
R5	R1 x10 on	Error
R6	R2 x10 on	Error
R7	R3 x10 on	Error
R8	R4 x10 on	Error
R9	Autorange off, stay on range	

Reading Rate (S)	
S0	1000/sec, 3½ digits
S1	75/sec, 3½ digits
S2	18/sec, 4½ digits
S3	10/sec, 4½ digits
S4	1/sec, 4½ digits

NOTE: Reading rates are nominal

Trigger (T)	
T0,0	One-shot on talk
T0,1	Sweep on talk
T1,0	One-shot on GET
T1,1	Sweep on GET
T2,0	One-shot on X
T2,1	Sweep on X
T3,0	One-shot on external pulse
T3,1	Sweep on external pulse
T4,0	One-shot on front panel
T4,1	Sweep on front panel

Status (U)	
U0	Hardware/software revision
U1	Error information
U2	Buffer A range group
U3	Buffer A trigger group
U4	Buffer A zero group
U5	Buffer A bias group
U6	Buffer A bias voltage
U7	Buffer A bias time
U8	Buffer A position and time
U9	Buffer B range group
U10	Buffer B trigger group
U11	Buffer B zero group
U12	Buffer B bias group
U13	Buffer B bias voltage
U14	Buffer B bias time
U15	Buffer B position and times
U16	Buffer A maximum/minimum capacitance
U17	Buffer A maximum/minimum conductance
U18	Buffer A maximum/minimum voltage
U19	Buffer B maximum/minimum capacitance
U20	Buffer B maximum/minimum conductance
U21	Buffer B maximum/minimum voltage
U22	Global parameters (series/parallel, C_0 value)
U23	Plotter parameters (plot, grid, line, etc.)
U24	IEEE output parameters (O, G, B, Y, K)
U25	IEEE input parameters (L, C, H, K, M)

Status (U) (Cont.)	
U26	Cable correction parameters
U27	Translator user name list
U28	Not used
U29	Translator reserved word list
U30	Translator NEW/OLD state
U31	Translator user translation list
U32	Not Used

Bias Voltage (V)	
V(first)(,last)(,step) (,default)(,count)	First=first bias; Last=last bias; Step=step bias; Default=default bias; $-20.000 \leq V \leq 20.000$ $1 \leq \text{count} \leq 450$ (1,350 at 1,000/sec rate)

Waveform (W)	
W(waveform)(,start) (,stop)(,step)	Waveform: 0=DC; 1=Single stair; 2=Dual stair; 3=Pulse; 4=External; Start=start time; Stop=stop time; Step=step time; $1\text{msec} \leq T \leq 65\text{sec}$

NOTE: Multiply programmed times by 1.024 to obtain actual times.

Execute (X)	
X	Execute Commands

Terminator (Y)	
Y0	<CR> <LF>
Y1	<LF> <CR>
Y2	<CR>
Y3	<LF>

Zero (Z)	
Z0	Disable zero
Z1	Enable zero

DATA FORMAT

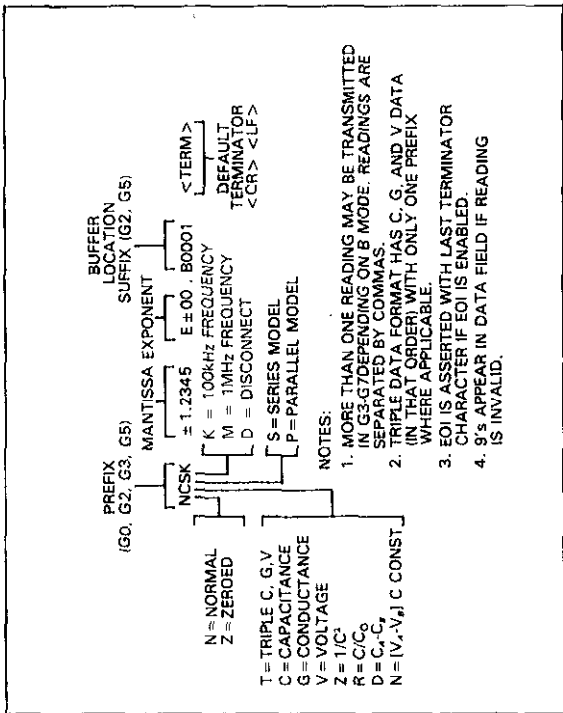

Figure 14. Data Format

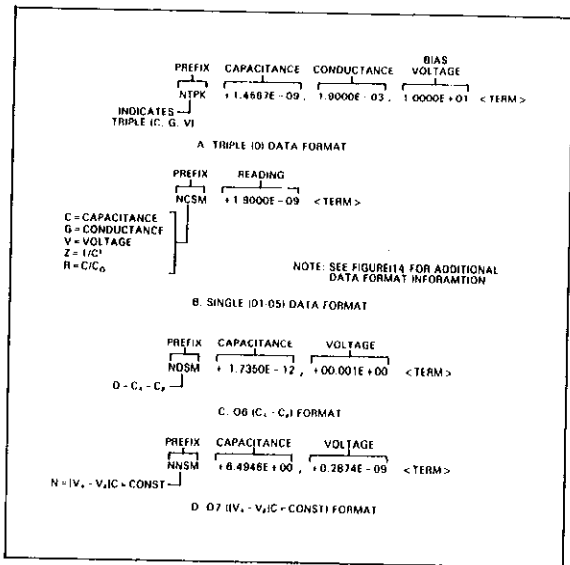

Figure 15. O Command Formats

SRQ MASK AND STATUS BYTE FORMAT

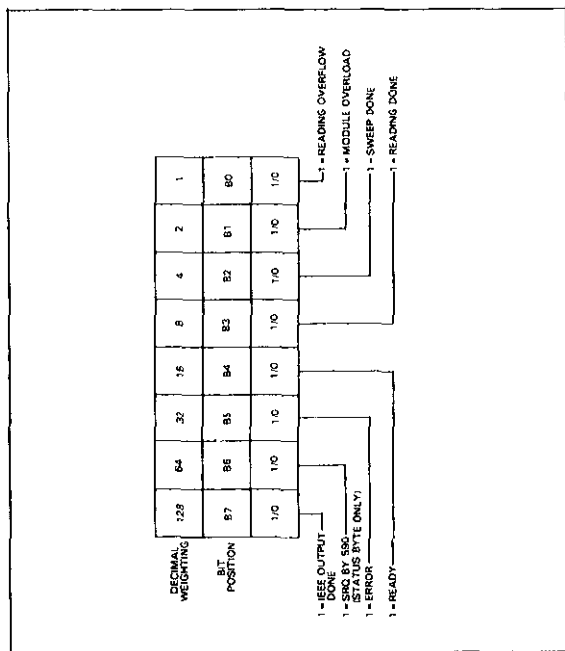
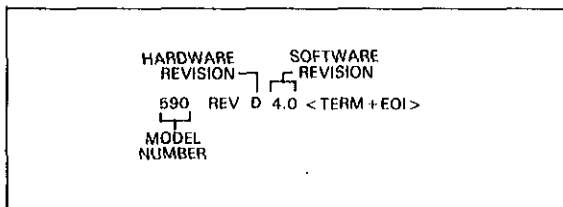

Figure 16. SRQ Mask and Status Byte Format

U0-U26 STATUS WORD FORMATS



**Figure 17. U0 Status Word Format
(Hardware/Software Revision)**

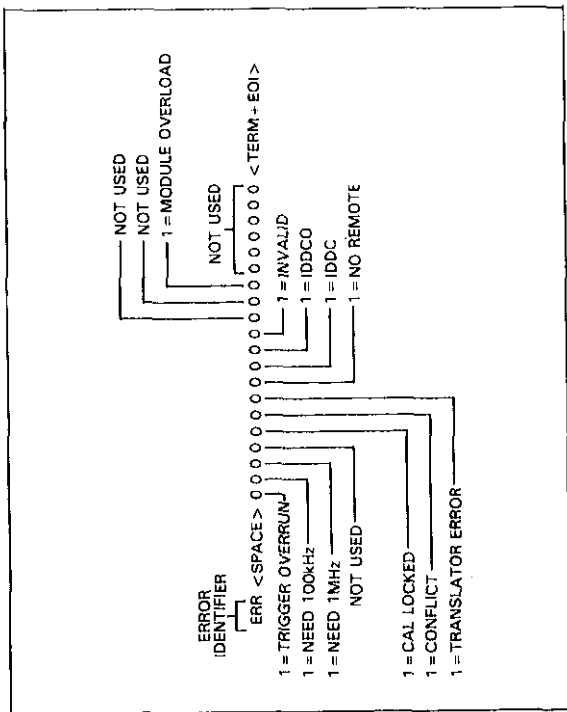

Figure 18. U1 Error Status Word Format

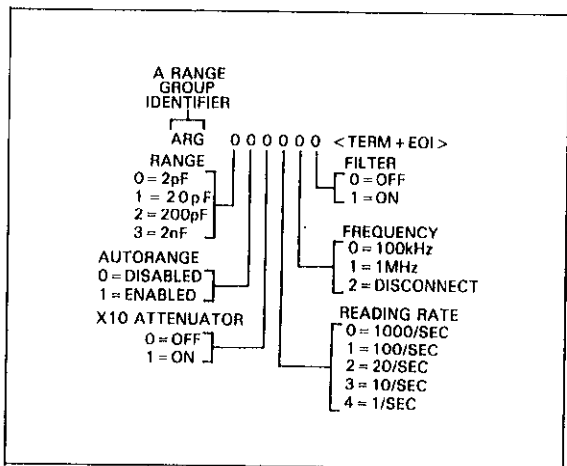

Figure 19. U2 Status Word Format (Buffer A Range Group)

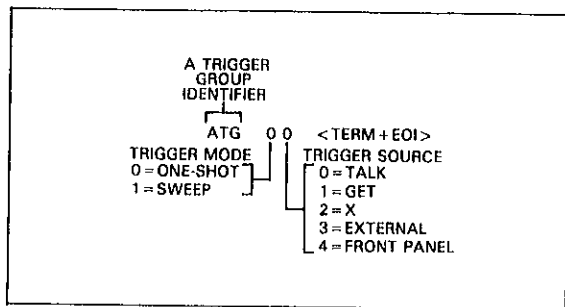

Figure 20. U3 Status Word Format (Buffer A Trigger Group)

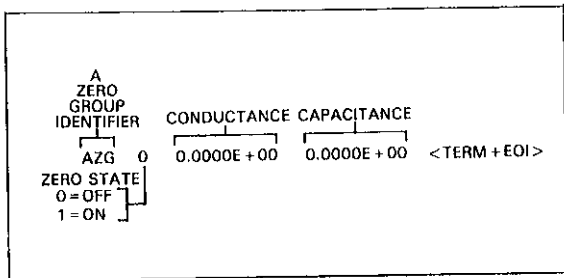

Figure 21. U4 Status Word Format (Buffer A Zero Group)

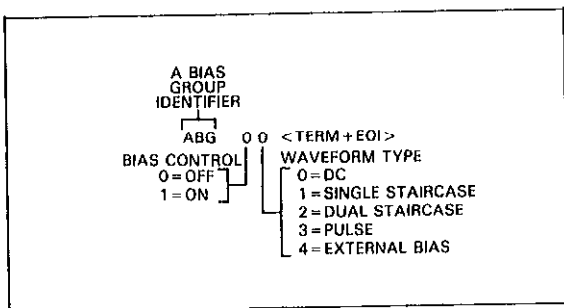

Figure 22. U5 Status Word Format (Buffer A Bias Group)

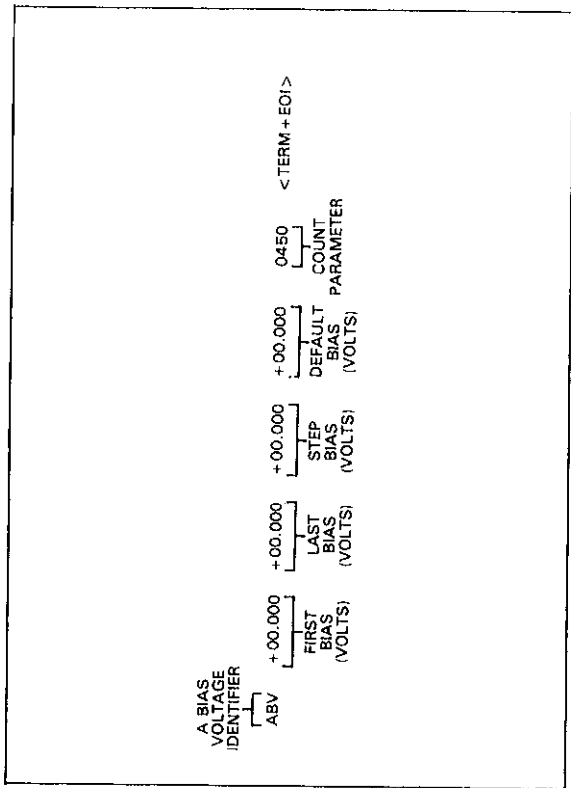

Figure 23. U6 Status Word Format (Buffer A Bias Voltages)

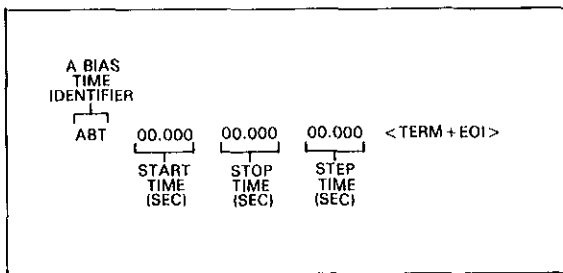

Figure 24. U7 Status Word Format (Buffer A Bias Times)

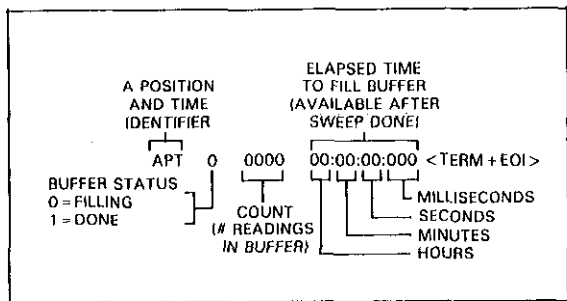

Figure 25. U8 Status Word Format (Buffer A Position and Time)

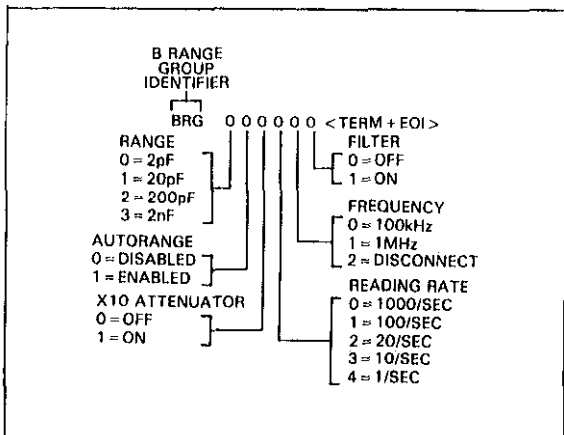

Figure 26. U9 Status Word Format (Buffer B Range Group)

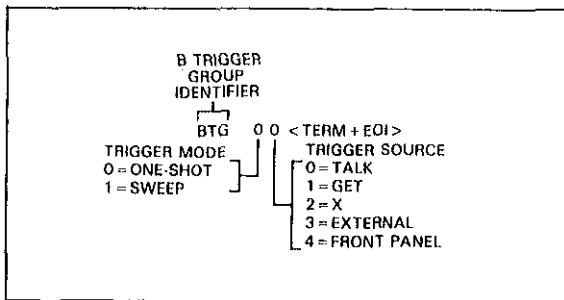

Figure 27. U10 Status Word Format (Buffer B Trigger Group)

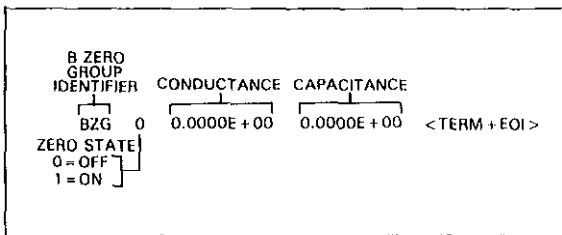

Figure 28. U11 Status Word Format (Buffer B Zero Group)

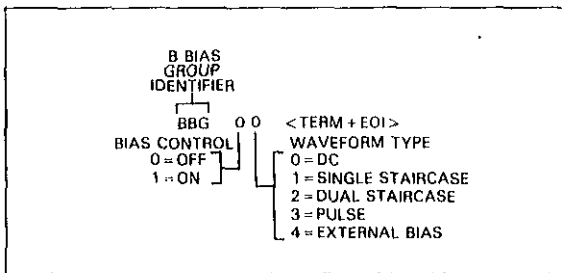

Figure 29. U12 Status Word Format (Buffer B Bias Group)

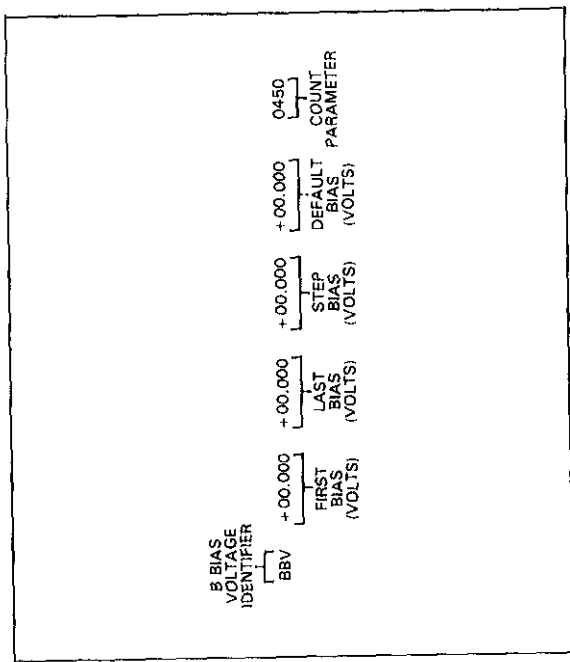

Figure 30. U13 Status Word Format (Buffer B Bias Voltages)

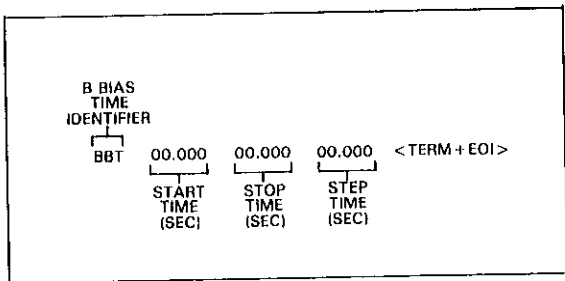

Figure 31. U14 Status Word Format (Buffer B Bias Times)

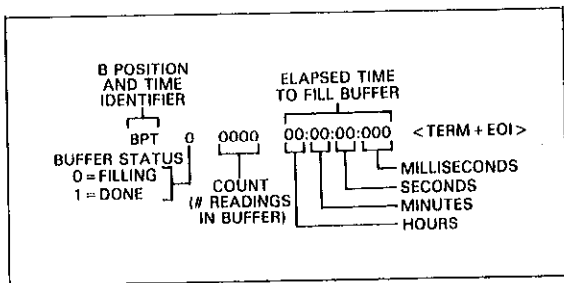
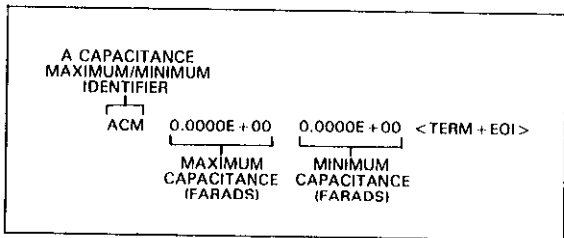
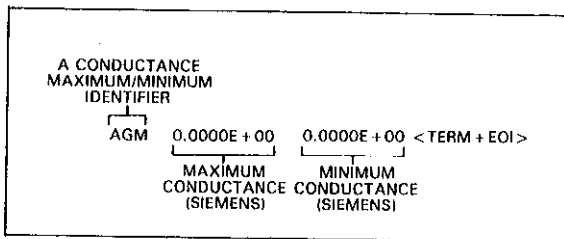

Figure 32. U15 Status Word Format (Buffer B Position and Time)



**Figure 33. U16 Status Word Format (Buffer A
Maximum and Minimum Capacitance)**



**Figure 34. U17 Status Word Format (Buffer A
Maximum and Minimum Conductance)**

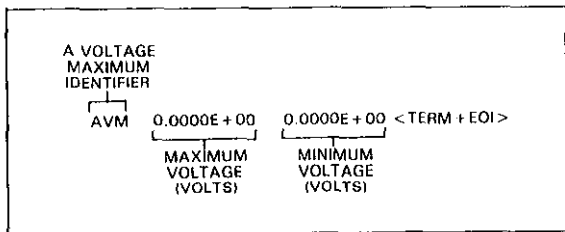

**Figure 35. U18 Status Word Format (Buffer A
Maximum and Minimum Voltage)**

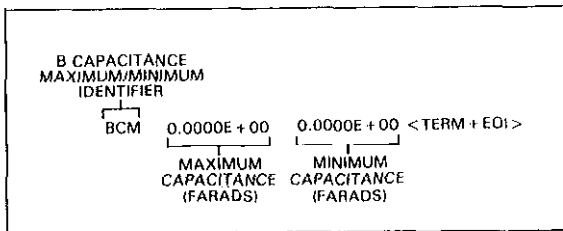

**Figure 36. U19 Status Word Format (Buffer B
B Maximum and Minimum Capacitance)**

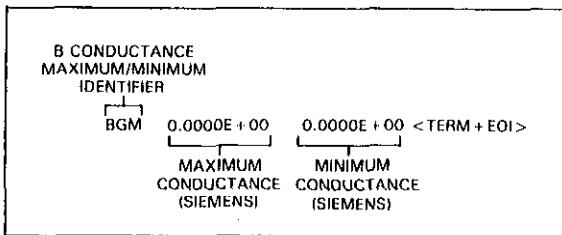

Figure 37. U20 Status Word Format (Buffer B Maximum and Minimum Conductance)

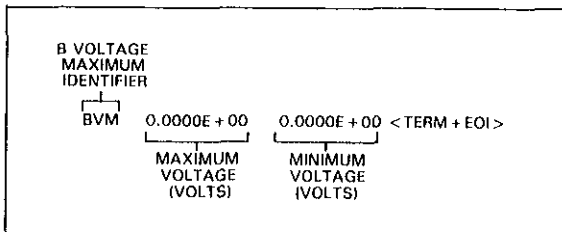
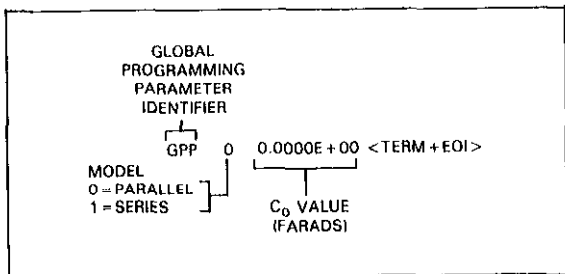
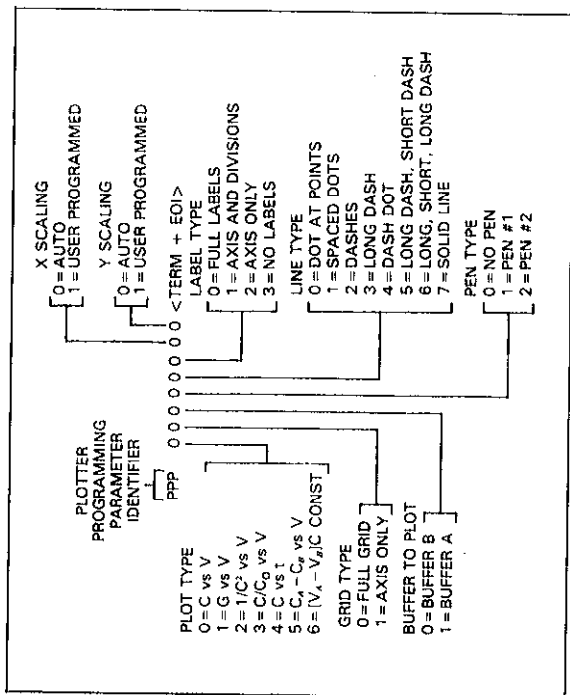

Figure 38. U21 Status Word Format (Buffer B Maximum and Minimum Voltage)



**Figure 39. U22 Status Word Format
(Global Programming Parameters)**



**Figure 40. U23 Status Word Format
(Plotter Programming Parameters)**

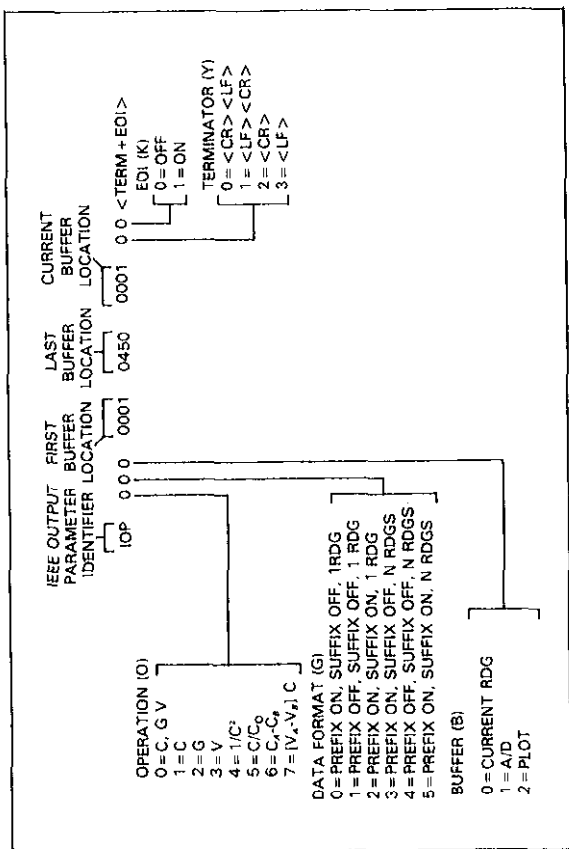
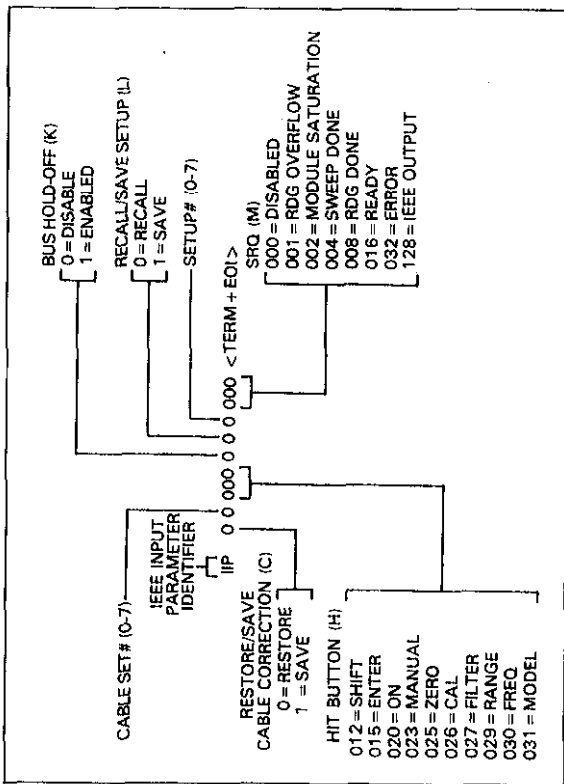
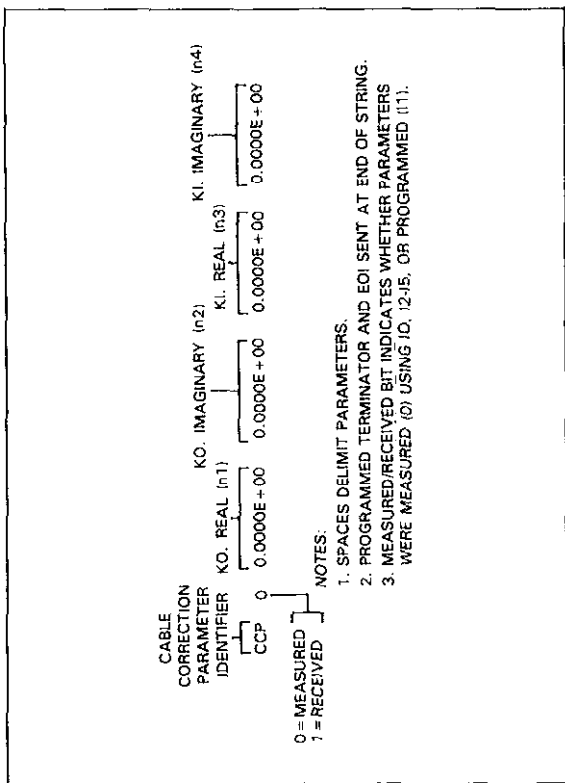

Figure 41. U24 Status Word Format
(IEEE Output Parameters)



**Figure 42. U25 Status Word Format
(IEEE Input Parameters)**



**Figure 43. U26 Status Word Format
(Cable Correction Parameters)**

TRANSLATOR

Table 1. Translator Reserved Words and Characters

Word or Character	Description
ALIAS	Define words, enable Translator
NEW	Enable Translator, combine words
OLD	Disable Translator
LIST	Get list of Translator words
FORGET	Erase Translator words
;	Terminate Translator definition string
\$	Wildcard to define parameter position

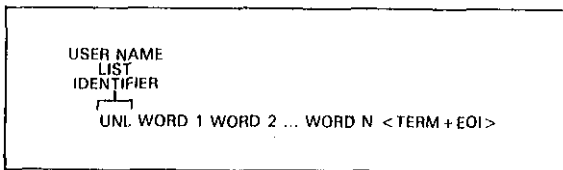
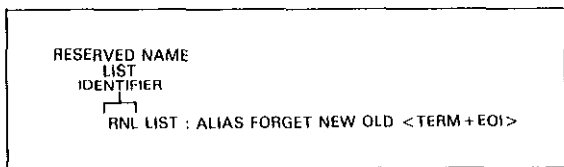

Figure 44. U27 Status Word Format
(Translator User Name List)



**Figure 45. U29 Status Word Format
(Reserved Name List)**

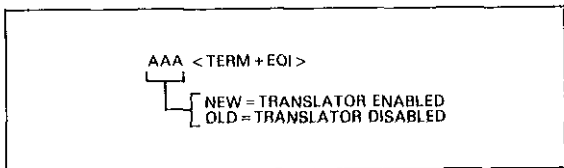
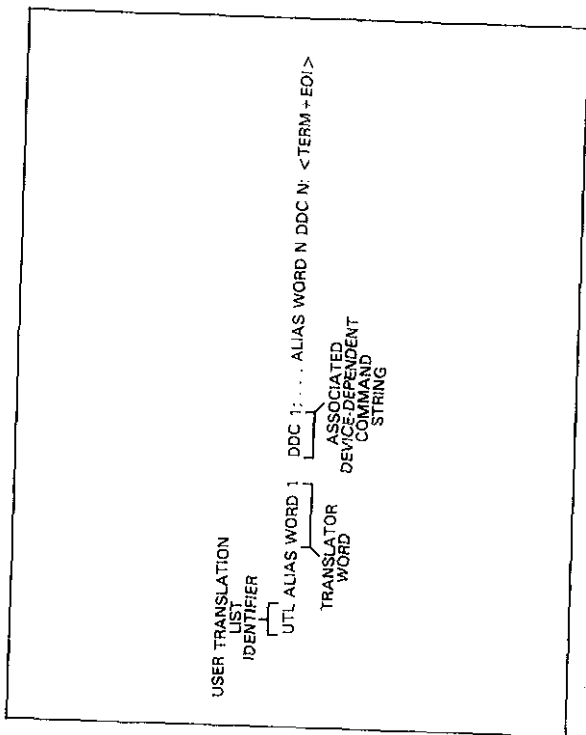

Figure 46. U30 Status Word Format (New/Old Status)



**Figure 47. U31 Status Word Format
(Translator User Translation List)**

PROGRAMS

The following programs are designed to be a simple aid to the user. They are not intended to suit specific needs. *Detailed programming information can be found in the manual.*

IBM PC or XT

(Keithley Model 8573A Interface)

The following program sends a command string to the Model 590 from an IBM PC or XT computer and displays the instrument reading string on the CRT. The computer must be equipped with the Keithley Model 8573A IEEE-488 Interface and the DOS 2.00 operating system. Model 8573A software must be installed and configured as described in the instruction manual.

DIRECTIONS

1. Using the front panel IEEE key, set the primary address of the Model 590 to 15.
2. With the power off, connect the Model 590 to the IEEE-488 interface installed in the IBM computer.
3. Type in BASICA on the computer keyboard to get into the IBM interpretive BASIC language.
4. Place the interface software disc in the default drive, type LOAD"DECL", and press the return key.
5. Add the lines below to lines 1-6 which are now in memory. Modify the address in lines 1 and 2, as described in the Model 8573A Instruction Manual.
6. Run the program and type in the desired command string. For example, to place the instrument in autorange and 1MHz frequency, type in ROF1X and press the return key.
7. The instrument reading string will then appear on the display. For example, the display might show NCPM + 1.2345E - 12.
8. To exit the program, type in EXIT at the command prompt and press the return key.

PROGRAM**COMMENTS**

10 CLS	Clear screen.
20 NA\$=' GPIB0' : CALL IBFIND (NA\$, BRD0%)	Find board descriptor.
30 NA\$=' DEV1' : CALL IBFIND (NA\$, M590%)	Find instrument descriptor.
40 U%=15 : CALL IBPAD (590%, U%)	Set primary address to 15.
50 U%=&H102 : CALL IBPOKE (BRD0%, U%)	Set timeouts.
60 U%=1 : CALL IBSRE (BRD0%, U%)	Set REN true.
70 INPUT ' COMMAND STRING' : CMD\$	Prompt for command.
80 IF CMD\$=' EXIT' THEN 150	See if program is to be halted.
90 IF CMD\$=' ' THEN 70	Check for null input.
95 CMD\$=CMD\$+CHR\$(32)	Add space for proper hold off.
100 CALL IBWRT (M590%, CMD\$)	Address 590 to listen, send string.
110 RD\$=SPACE\$(100)	Define reading input buffer.
120 CALL IBRD (M590%, RD\$)	Address 590 to talk, get reading.
130 PRINT RD\$	Display the string.
140 GOTO 70	Repeat.
150 U%=0 : CALL IBONL (M590%, U%)	Close the instrument file.
160 CALL IBONL (BRD0%, U%)	Close the board file.

NOTE: For conversion to numeric variable, make the following changes:

```
130 RD=VAL (MID$(RD$, 5,  
15))  
135 PRINT RD
```

APPLE II

(APPLE II IEEE-488 Interface)

The following program sends a command string to the Model 590 from an Apple II computer and displays the instrument reading string on the computer CRT.

The computer must be equipped with the Apple II IEEE-488 Interface installed in slot 5. Note that the program assumes that the computer is running under Apple DOS 3.3 or ProDOS.

DIRECTIONS

1. Using the front panel IEEE key, set the primary address of the Model 590 to 15.
2. With the power off, connect the Model 590 to the IEEE-488 interface installed in the Apple II computer.
3. Enter the lines in the program below, using the RETURN key after each line.
4. Run the program and type in the desired command string at the command prompt. For example, to place the instrument in the autorange and 1MHz modes, type in ROF1X and press the return key.
5. The instrument reading string will then appear on the CRT. A typical display is: NCPK + 1.2345E - 12.

PROGRAM	COMMENTS
10 Z\$=CHR\$(26): D\$=CHR\$(4)	Terminator.
20 ADDR=15: SLOT=5	Define address, slot variables.
30 INPUT 'COMMAND STRING'; B\$	Input command string.
40 PRINT D\$; 'PR#'; SLOT	Set output to IEEE-488 bus.
50 PRINT D\$; 'IN#'; SLOT	Define input from IEEE-488 bus.
60 PRINT 'RA'	Enable remote.
70 PRINT 'LF1'	Line feed on.
80 PRINT 'WT'; CHR\$(32+ADDR); Z\$; B\$	Address 590 to listen, send string.
90 PRINT 'RD'; CHR\$(64+ADDR); Z\$	Address 590 to talk.
100 INPUT ''; A\$	Input data.
110 PRINT 'UT'	Untalk the bus.
120 PRINT D\$; 'PR#0'	Define output to CRT.
130 PRINT D\$; 'IN#0'	Define input from keyboard.
140 PRINT A\$	Display string.
150 GOTO 30	Repeat.

NOTES:

1. If conversion to numeric variable is required, make the following changes:

```
120 A=VAL(MID$(A$,5,15))
125 PRINT A
```

2. The Apple II INPUT statement terminates on commas. To avoid problems, program the Model 590 for the O1, O2, or O3 data format to eliminate commas.

HP 85

The following program sends a command string to the Model 590 from an HP-85 computer and displays the instrument reading string on the computer CRT. The computer must be equipped with the HP82937 GPIB Interface and an I/O ROM.

DIRECTIONS

1. Using the front panel IEEE key, set the primary address of the Model 590 to 15.
2. With the power off, connect the Model 590 to the HP82937A GPIB interface installed in the HP-85 computer.
3. Enter the lines in the program below, using the END LINE key after each line.
4. Press the HP-85 RUN key and type in the desired command string at the command prompt. For example, to place the instrument in the autorange and 1MHz modes, type in ROF1X and press the END LINE key.
5. The instrument reading string will then appear on the CRT. A typical display is: NCPM + 1.2345E - 12.

PROGRAM	COMMENTS
10 DIM A#[25], B#[50]	Dimension strings.
20 REMOTE 715	Place 590 in remote.
30 DISP 'COMMAND STRING';	Prompt for command.
40 INPUT A#	Input command string.
50 OUTPUT 715; A#	Address 590 to listen, send string.
60 ENTER 715; B#	Address 590 to talk, in- put reading.
70 DISP B#	Display reading string.
80 GOTO 30	Repeat
90 END	

NOTE: For conversion to numeric variable, change line 70 as follows:

```
70 DISP VAL(B#[5,15])
```

HP 9816

The following program sends a command string to the Model 590 from a Hewlett-Packard Model 9816 computer and displays the instrument reading string on the computer CRT. The computer must be equipped with the HP82937 GPIB Interface and BASICA 2.0.

DIRECTIONS

1. Using the front panel IEEE key, set the primary address of the Model 590 to 15.
2. With the power off, connect the Model 590 to the HP82937A GPIB interface installed in the 9816 computer.
3. Type EDIT and press the EXEC key.
4. Enter the lines in the program below, using the ENTER key after each line.
5. Press the 9816 RUN key and type in the desired command string at the command prompt. For example, to place the instrument in the autorange and 1MHz modes, type in ROF1X and press the ENTER key.
6. The instrument reading string will then appear on the CRT. A typical display is: NCPM + 1.2345E - 12.

PROGRAM	COMMENTS
10 REMOTE 715	Place 590 in remote.
15 DIM B\$(50)	Dimension string.
20 INPUT "COMMAND STRING", A\$	Prompt for and input command.
30 OUTPUT 715; A\$	Address 590 to listen, send string.
40 ENTER 715; B\$	Address 590 to talk, in- put reading.
50 PRINT B\$	Display reading string.
60 GOTO 20	Repeat.
70 END	

NOTE: For conversion to a numeric variable, change the program as follows:

```
40 ENTER 715; B
50 PRINT B
```

HP 9825A

Use the following program to send a command string to the Model 590 from a Hewlett-Packard Model 9825A and display the instrument reading string on the computer printer. The computer must be equipped with the HP98034A HPIB Interface and a 9872A extended I/O ROM.

DIRECTIONS

1. From the front panel, set the primary address of the Model 590 to 15.
2. With the power off, connect the Model 590 to the 98034A HPIB interface installed in the 9825A.
3. Enter the lines in the program below, using the STORE key after each line. Line numbers are automatically assigned by the 9825A.
4. Press the 9825A RUN key and type in the desired command string at the command prompt. For example, to place the instrument in the autorange and 1MHz modes, type in R0F1X and press the CONT key.
5. The instrument reading string will then appear on the computer print out. A typical display is:
NCPM + 1.2345E - 12.

PROGRAM**COMMENTS**

0 dim A#[50],B#[20]	Dimension data strings.
1 dev'590',715	Define 590 at address 15.
2 rem'590'	Place 590 in remote.
3 ent'COMMAND STRING', B#	Prompt for command string.
4 wrt'590',B#	Address 590 to listen, send string.
5 red'590',A#	Address 590 to talk, input data.
6 prt A#	Print data string on printer.
7 gto 3	Repeat.

NOTE: For conversion to numeric variable, modify the program as follows:

6 prt val(A#[5])

DEC LSI 11

The following program sends a command string to the Model 590 from a DEC LSI 11 minicomputer and displays the instrument reading string on the DEC CRT terminal. The LSI 11 must be configured with 16K words of RAM and an IBV 11 IEEE-488 interface. The software must be configured with the IB software as well as FORTRAN and the RT 11 operating system.

DIRECTIONS

1. Using the front panel IEEE key, set the primary address of the Model 590 to 15.
2. With the power off, connect the Model 590 to the IBV 11 IEEE-488 interface cable.
3. Enter the program below, using the editor under RT 11 and the name IEEE.FOR.
4. Compile using the FORTRAN compiler as follows: FORTRAN IEEE.
5. Link with the system and IB libraries as follows: LINK IEEE,IBLIB.
6. Type RUN IEEE and press the RETURN key.
7. The display will read "ENTER ADDRESS".
8. Type in 15 and press the RETURN key.
9. The display will read "TEST SETUP".
10. Type in the desired command string and press the RETURN key. For example, to program the instrument for the autorange and 1MHz modes, type in ROF1X and press RETURN.
11. The instrument data string will appear on the computer display. A typical display is: NCPM + 1.2345E - 12.

PROGRAM**COMMENTS**

PROGRAM IEEE	
INTEGER*2 PRIADR	
LOGICAL*1 MSG(80),	
INPUT(80)	
DO 2 I = 1, 10	
CALL IBSTER(1, 0)	Turn off IB errors.
2 CONTINUE	
CALL IBSTER(15, 5)	Allow 5 error 15's.
CALL IBTIMO(120)	Allow 1 second bus timeout.
CALL IBTERM(10)	Set line feed as terminator.
CALL IBREN	Turn on remote.
4 TYPE 5	
5 FORMAT (1X, 'ENTER ADDRESS: ', \$) ACCEPT 10, PRIADR	Input primary address.
10 FORMAT (I2)	
12 TYPE 15	
15 FORMAT (1X, 'TEST SETUP: ', \$)	Prompt for command string.
CALL GETSTR (5, MSG, 72)	Program instrument.
CALL IBSEOI (MSG, -1, PRIADR)	Address 590 to listen, send string.
18 I=IBRECV (INPUT, 80, PRIADR)	Get data from instru- ment.
INPUT (I+1) = 0	
CALL PUTSTR (7, INPUT, '0')	
CALL IBUNT	Untalk the 590.
GOTO 12	Repeat.
END	

PET/CBM 2001

The following program sends a command string to the Model 590 from a PET/CBM 2001 computer and displays the instrument reading string on the computer CRT. As the PET/CBM computer has a standard IEEE-488 interface, no additional equipment is necessary.

DIRECTIONS

1. Using the front panel IEEE key, set the primary address of the Model 590 to 15.
2. With the power off, connect the Model 590 to the PET/CBM IEEE-488 interface.
3. Enter the lines of the program below, using the RETURN key after each line is typed.
4. Type RUN and press the RETURN key. Type in the desired command string at the command prompt. For example, to place the instrument in the autorange and 1MHz modes, type in ROF1X and press the RETURN key.
5. The instrument reading string will then appear on the CRT. A typical display is: NCPM + 1.2345E - 12.

PROGRAM	COMMENTS
10 OPEN 1,15	Open file 1, primary address 15.
20 INPUT ' 'COMMAND STRING' ';B\$	Prompt for, input command string.
30 PRINT#1,B\$	Address 590 to listen, send string.
40 INPUT#1,A\$	Address 590 to talk, input data.
50 IF ST = 2 THEN 40	If bus timeout, input again.
60 PRINT A\$	Display reading string.
70 GOTO 20	Repeat.

NOTES:

1. If conversion to numeric variable is required, modify the program as follows:

```
60 A = VAL(MID$(A$,5,15))
70 PRINT A
80 GOTO 20
```

2. The PET INPUT# statement terminates on a comma. Thus, when reading Model 590 strings which include commas, you should input each portion of the string into a separate string variable. For example, in the OO mode, to obtain and display readings, the program above can be modified as follows:

```
40 INPUT#1, A$, B$, C$
60 PRINT A$ ' ', ' ' B$ ' ', ' ' C$
```

The following safety precautions should be observed before using this product and any associated instrumentation. Although some instruments and accessories would normally be used with non-hazardous voltages, there are situations where hazardous conditions may be present.

This product is intended for use by qualified personnel who recognize shock hazards and are familiar with the safety precautions required to avoid possible injury. Read and follow all installation, operation, and maintenance information carefully before using the product. Refer to the manual for complete product specifications.

If the product is used in a manner not specified, the protection provided by the product may be impaired.

The types of product users are:

Responsible body is the individual or group responsible for the use and maintenance of equipment, for ensuring that the equipment is operated within its specifications and operating limits, and for ensuring that operators are adequately trained.

Operators use the product for its intended function. They must be trained in electrical safety procedures and proper use of the instrument. They must be protected from electric shock and contact with hazardous live circuits.

Maintenance personnel perform routine procedures on the product to keep it operating properly, for example, setting the line voltage or replacing consumable materials. Maintenance procedures are described in the manual. The procedures explicitly state if the operator may perform them. Otherwise, they should be performed only by service personnel.

Service personnel are trained to work on live circuits, and perform safe installations and repairs of products. Only properly trained service personnel may perform installation and service procedures.

Keithley products are designed for use with electrical signals that are rated Installation Category I and Installation

Category II, as described in the International Electrotechnical Commission (IEC) Standard IEC 60664. Most measurement, control, and data I/O signals are Installation Category I and must not be directly connected to mains voltage or to voltage sources with high transient over-voltages. Installation Category II connections require protection for high transient over-voltages often associated with local AC mains connections. Assume all measurement, control, and data I/O connections are for connection to Category I sources unless otherwise marked or described in the Manual.

Exercise extreme caution when a shock hazard is present. Lethal voltage may be present on cable connector jacks or test fixtures. The American National Standards Institute (ANSI) states that a shock hazard exists when voltage levels greater than 30V RMS, 42.4V peak, or 60VDC are present. **A good safety practice is to expect that hazardous voltage is present in any unknown circuit before measuring.**

Operators of this product must be protected from electric shock at all times. The responsible body must ensure that operators are prevented access and/or insulated from every connection point. In some cases, connections must be exposed to potential human contact. Product operators in these circumstances must be trained to protect themselves from the risk of electric shock. If the circuit is capable of operating at or above 1000 volts, **no conductive part of the circuit may be exposed.**

Do not connect switching cards directly to unlimited power circuits. They are intended to be used with impedance limited sources. NEVER connect switching cards directly to AC mains. When connecting sources to switching cards, install protective devices to limit fault current and voltage to the card. Before operating an instrument, make sure the line cord is connected to a properly grounded power receptacle. Inspect the connecting cables, test leads, and jumpers for possible wear, cracks, or breaks before each use.

When installing equipment where access to the main power cord is restricted, such as rack mounting, a separate main input power disconnect device must be provided, in close proximity to the equipment and within easy reach of the operator.

For maximum safety, do not touch the product, test cables, or any other instruments while power is applied to the circuit under test. ALWAYS remove power from the entire test system and discharge any capacitors before: connecting or disconnecting cables or jumpers, installing or removing switching cards, or making internal changes, such as installing or removing jumpers.

Do not touch any object that could provide a current path to the common side of the circuit under test or power line (earth) ground. Always make measurements with dry hands while standing on a dry, insulated surface capable of withstanding the voltage being measured.



The instrument and accessories must be used in accordance with its specifications and operating instructions or the safety of the equipment may be impaired.

Do not exceed the maximum signal levels of the instruments and accessories, as defined in the specifications and operating information, and as shown on the instrument or test fixture panels, or switching card.

When fuses are used in a product, replace with same type and rating for continued protection against fire hazard.

Chassis connections must only be used as shield connections for measuring circuits, NOT as safety earth ground connections.

If you are using a test fixture, keep the lid closed while power is applied to the device under test. Safe operation requires the use of a lid interlock.

If  or  is present, connect it to safety earth ground using the wire recommended in the user documentation.

The  symbol on an instrument indicates that the user should refer to the operating instructions located in the manual.

The  symbol on an instrument shows that it can source or measure 1000 volts or more, including the combined effect

of normal and common mode voltages. Use standard safety precautions to avoid personal contact with these voltages.

The **WARNING** heading in a manual explains dangers that might result in personal injury or death. Always read the associated information very carefully before performing the indicated procedure.

The **CAUTION** heading in a manual explains hazards that could damage the instrument. Such damage may invalidate the warranty.

Instrumentation and accessories shall not be connected to humans.

Before performing any maintenance, disconnect the line cord and all test cables.

To maintain protection from electric shock and fire, replacement components in mains circuits, including the power transformer, test leads, and input jacks, must be purchased from Keithley Instruments. Standard fuses, with applicable national safety approvals, may be used if the rating and type are the same. Other components that are not safety related may be purchased from other suppliers as long as they are equivalent to the original component. (Note that selected parts should be purchased only through Keithley Instruments to maintain accuracy and functionality of the product.) If you are unsure about the applicability of a replacement component, call a Keithley Instruments office for information.

To clean an instrument, use a damp cloth or mild, water based cleaner. Clean the exterior of the instrument only. Do not apply cleaner directly to the instrument or allow liquids to enter or spill on the instrument. Products that consist of a circuit board with no case or chassis (e.g., data acquisition board for installation into a computer) should never require cleaning if handled according to instructions. If the board becomes contaminated and operation is affected, the board should be returned to the factory for proper cleaning/servicing.

Specifications are subject to change without notice.

All Keithley trademarks and trade names are the property of Keithley Instruments, Inc. All other trademarks and trade names are the property of their respective companies.



Keithley Instruments, Inc.

28775 Aurora Road • Cleveland, Ohio 44139

440-248-0400 • Fax: 440-248-6168

1-888-KEITHLEY (534-8453) www.keithley.com

© Copyright 2000 Keithley Instruments, Inc.

Printed in the U.S.A.

04/2001